

Herz-, Thorax- und Gefäß-Chirurgie
Cardiovascular and Thoracic Surgery
Chirurgie cardiovasculaire et Thoracoplastie
Cirugía cardiovascular y Toracoplástica



Knochen-und rippen scheren
 Bone and rib shears
 Costotomes, cisailles pour os
 Cizallas para huesos y costillas

mit ziehendem Schnitt
 with eccentric sliding blade
 avec lame glissante
 con hoja de retroacción



28.3859
 22,0 cm/8³/₄"

Rippenschere
 Rib Shears
 Costotomes
 Cizallas para costillas



28.3860-19 19,5 cm/7³/₄"
 28.3860-23 22,5 cm/9"

Knochenschere
 Bone Shears
 Cisailles pour os
 Cizallas para huesos



Gluck
 28.3861
 21,0 cm/8³/₄"

Rippenschere
 Rib Shears
 Costotomes
 Cizallas para costillas

28

Rippen scheren
 Rib shears
 Costotomes
 Cizallas para costillas

Griffe mit Gummiüberzug
 Handles with rubber cover
 Manches avec couverture en caoutchouc
 Mangos con cubierta de goma



Bethune

28.3863
 34,0 cm/13½"



Giertz-Style

28.3864
 27,0 cm/10½"



Brunner

32,0 cm/12½"

28.3865
 für die rechte Hand
 for the right hand
 pour la main droite
 para la mano derecha

28.3866
 für die linke Hand
 for the left hand
 pour la main gauche
 para la mano izquierda

Knochen-und rippen scheren
 Bone and rib shears
 Costotomes, Cisailles pour os
 Cizallas para huesos y costillas

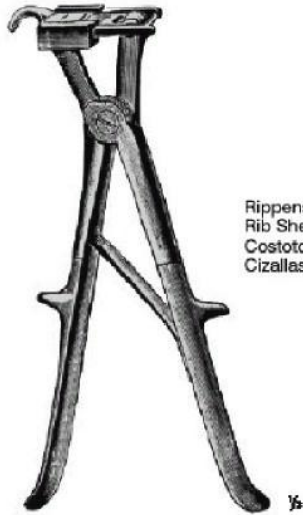

Rippenschere
 Rib Shears
 Costotomes
 Cizallas para costillas

Sauerbruch
 28.3867
 26,0 cm/10¼"



Rippenschere
 Rib Shears
 Costotomes
 Cizallas para costillas

Sauerbruch-Frey
 28.3868
 36,0 cm/14"

28



Sternumschere
 Sternum scissors
 Cisailles à sternum
 Tijeras de esternón

Lebsche
 28.3869
 25,0 cm/10"



Sternummeißel
 Sternum chisel
 Burin à sternum
 Cincel de esternón

Lebsche
 28.3871
 24,5 cm/9¾"

Rippen sperrer aus aluminium
 Rib spreaders from aluminium
 Ecarteurs des cotes en aluminium
 Separadores costales de aluminio



Aluminium
 Aluminium
 Aluminium
 Aluminio

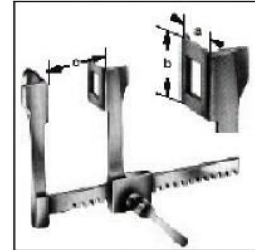

Finocchietto-Infant

	a	b	c
28.3880	10 mm	15 mm	70 mm



Aluminium
 Aluminium
 Aluminium
 Aluminio

Finocchietto-Baby-Haight

	a	b	c
28.3881	31 mm	31 mm	80 mm



Aluminium
 Aluminium
 Aluminium
 Aluminio

Finocchietto

	a	b	c
28.3882-01	30 mm	45 mm	140 mm
28.3882-02	40 mm	62 mm	175 mm
28.3882-03	64 mm	65 mm	175 mm

Rippen sperrer aus aluminium
 Rib spreaders from aluminium
 Ecarteurs des cotes en aluminium
 Separadores costales de aluminio



Aluminium
 Aluminium
 Aluminium
 Aluminio

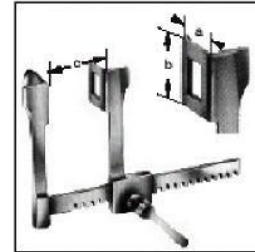

für Kinder
 for children
 pour enfants
 para niños

mit 2 Paar Valven
 with 2 pairs of blades
 avec 2 paires de valves
 con 2 pares de valvas

Burford	a	b	c
28.3884	41 mm 30 mm	42 mm 42 mm	130 mm



Aluminium
 Aluminium
 Aluminium
 Aluminio

28

für Erwachsene
 for adults
 pour adultes
 para adultos

mit 2 Paar Valven
 with 2 pairs of blades
 avec 2 paires de valves
 con 2 pares de valvas

Burford	a	b	c
28.3885-01	65 mm 47 mm	62 mm 62 mm	165 mm
28.3885-02	65 mm 47 mm	62 mm 62 mm	250 mm
28.3885-03	65 mm 47 mm	62 mm 62 mm	290 mm

Rippen sperrer aus aluminium
 Rib spreaders from aluminium
 Ecarteurs des cotes en aluminium
 Separadores costales de aluminio



Aluminium
 Aluminium
 Aluminium
 Aluminio

für Säuglinge
 for newborns
 pour bébés
 para recién nacidos

Cooley	a	b	c
28.3887-01	12 mm	16 mm	70 mm



Aluminium
 Aluminium
 Aluminium
 Aluminio

für Kinder
 for children
 pour enfants
 para niños

Cooley	a	b	c
28.3887-02	15 mm	30 mm	100 mm



Aluminium
 Aluminium
 Aluminium
 Aluminio

für Erwachsene
 for adults
 pour adultes
 para adultos

Cooley	a	b	c
28.3887-03	21 mm	44 mm	140 mm
28.3887-04	30 mm	50 mm	185 mm

Rippen sperrer aus aluminium
 Rib spreaders from aluminium
 Ecarteurs des cotes en aluminium
 Separadores costales de aluminio



Aluminium
 Aluminium
 Aluminium
 Aluminio

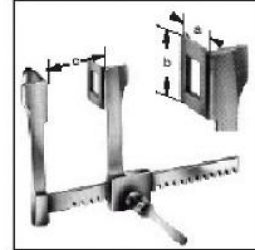

für Säuglinge
 for newborns
 pour bébés
 para recién nacidos

Castañeda	a	b	c
28.3890-01	10,5 mm	32 mm	65 mm

für Kinder
 for children
 pour enfants
 para niños

Castañeda	a	b	c
28.3890-02	12 mm	45 mm	70 mm
28.3890-03	15 mm	60 mm	100 mm



Aluminium
 Aluminium
 Aluminium
 Aluminio

Morse

	a	b	c
28.3892	20 mm	20 mm	165 mm

Rippen sperrer
 Rib spreaders
 Ecarteurs des cotes
 Separadores costales

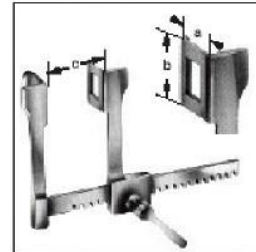

Finocchietto-Baby

	a	b	c
28.3900	19 mm	20 mm	75 mm

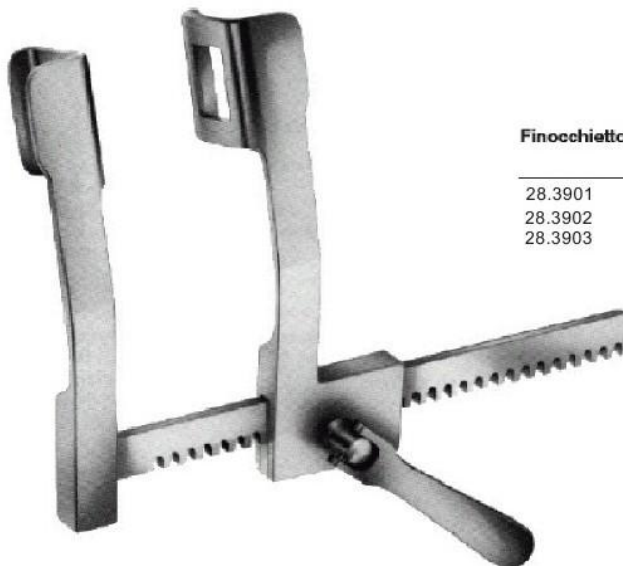

Finocchietto

	a	b	c
28.3901	40 mm	45 mm	165 mm
28.3902	45 mm	65 mm	200 mm
28.3903	65 mm	65 mm	250 mm

Rippen sperrer
 Rib spreaders
 Ecarteurs des cotes
 Separadores costales

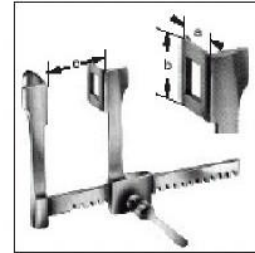
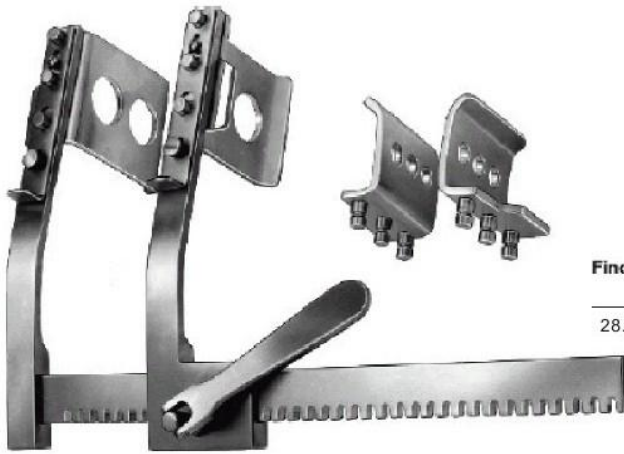

Finocchietto-Burford

	a	b	c
28.3904	80 mm 40 mm	67 mm 67 mm	250 mm

mit 2 Paar Valven
 with 2 pairs of blades
 avec 2 paires de valves
 con 2 pares de valvas

28



Tuffier

	a	b	c
28.3905	50 mm	45 mm	165 mm

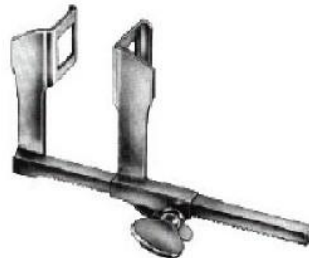

Haight

	a	b	c
28.3906	30 mm	30 mm	90 mm

Rippen sperrer
 Rib spreaders
 Ecarteurs des cotes
 Separadores costales

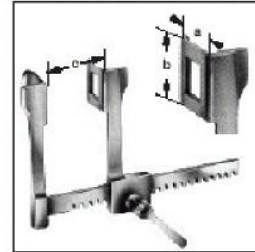

für Kinder
 for children
 pour enfants
 para niños

Cooley	a	b	c
28.3907-01	21 mm	45 mm	145 mm



für Erwachsene
 for adults
 pour adultes
 para adultos

Cooley	a	b	c
28.3907-02	32 mm	50 mm	190 mm

Rippen sperrer
 Rib spreaders
 Ecarteurs des cotes
 Separadores costales

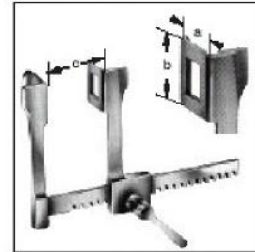

Morse	a	b	c
28.3908-01	12 mm	20 mm	200 mm

Morse	a	b	c
28.3908-02	19 mm	19 mm	200 mm

28



Morse-Favaloro	a	b	c
28.3908-03	38 mm	28 mm	200 mm

Rippen sperrer
 Rib spreaders
 Ecarteurs des cotes
 Separadores costales

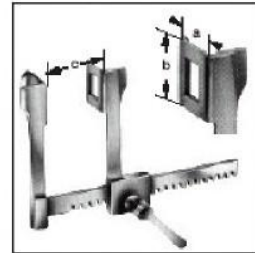

mit 1 Paar zusätzlich abnehmbaren Valven
 with 1 pair of additional detachable blades
 avec 1 paire de valves démontables, supplémentaire
 con 1 par de valvas desmontables, adicional



a	b
40 mm	50 mm

28

Harken

	a	b	c
28.3909	45 mm	65 mm	250 mm

Rippen kontraktoren	Lung spatel
Rib contractors	Lung spatulas
Rapprocheurs costaux	Spatules pulmonaires
Approximadores para costillas	Espatulas pulmonares



Bailey-Gibbon
28.3910
16,0 cm/6¼"



Bailey
28.3911
16,0 cm/6¼"

28



Bailey-Baby
28.3912
14,0 cm/5½"



Lungenspatel
Lung Spatulas
Spatules pulmonaires
Espátulas pulmonares

Allison

28.3920-27 40 mm
27,0 cm/11"

28.3920-32 65 mm
32,0 cm/12½"

Lungenfaß zangen
 Lung grasping forceps
 Pincès-clamps a poumons
 Pinzas clamps pulmonares

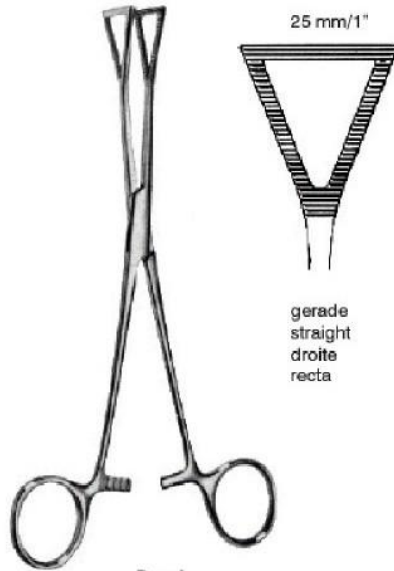

gerade
 straight
 droite
 recta

Duval

28.4052 28.4054
 20,0 cm/8" 23,0 cm/9¼"

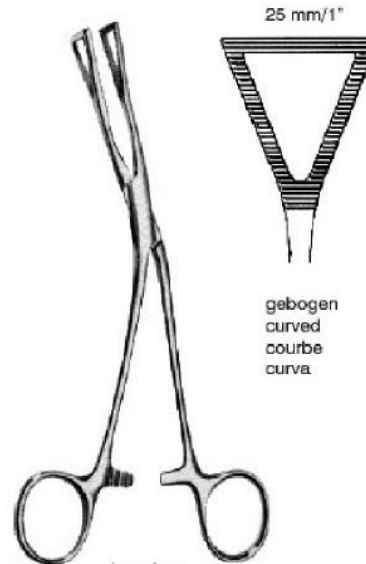

gebogen
 curved
 courbe
 curva

Lovelace

28.4053
 20,0 cm/8"



Collin

13 mm/½"
 28.4057
 20,0 cm/8"

25 mm/1"
 28.4058
 20,0 cm/8"
 28.4059
 23,0 cm/9¼"

Bronchus klemmen
 Brochus clamps
 Pinces-clamps a broches
 Pinzas-clamps para bronquios

Gafab klemmen
 Blood vessel clamps
 Pinces vasculaires
 Clamps para vasos

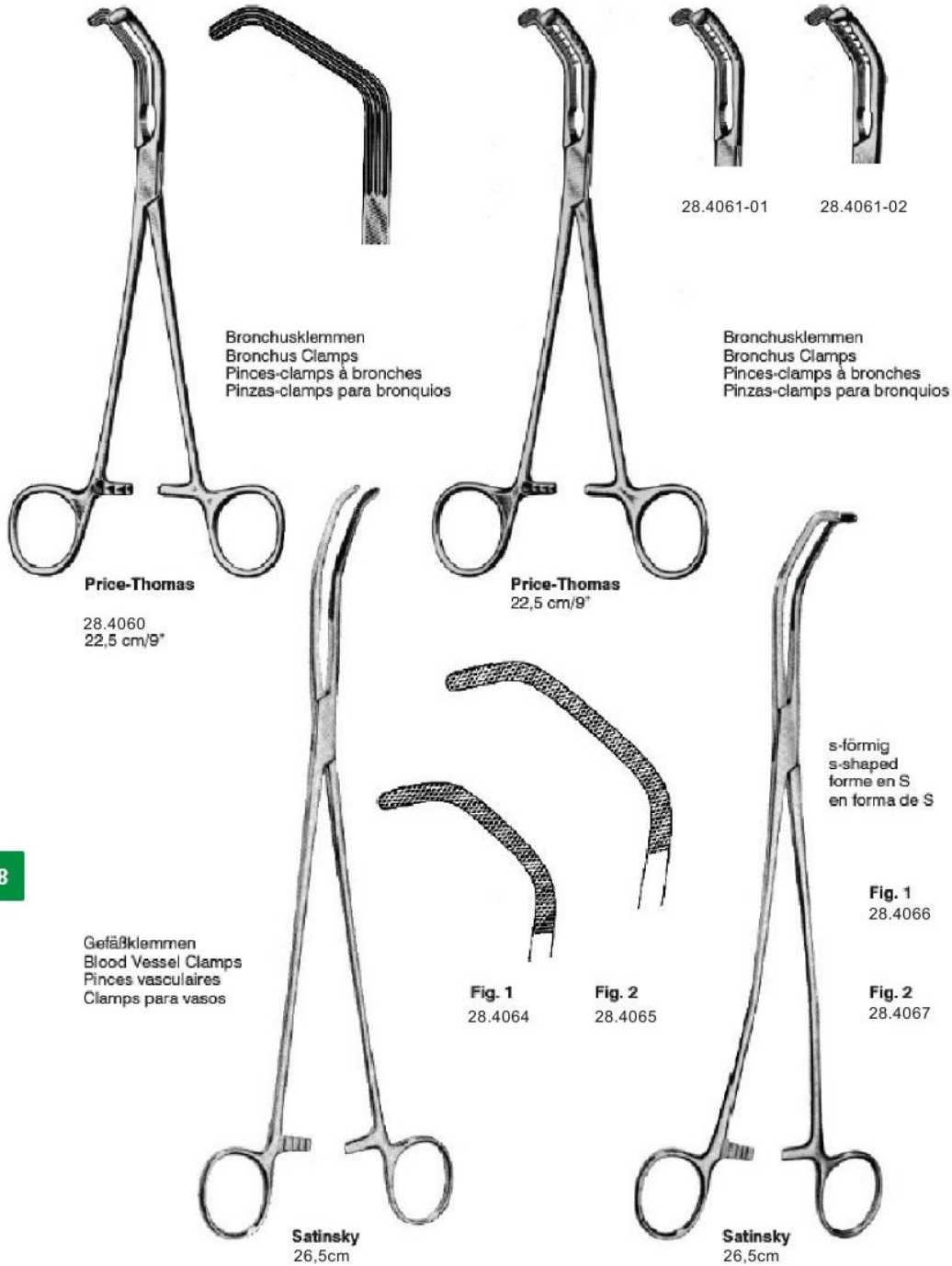

Gafab klemmen
Blood vessel clamps
Pincas vasculaires
Clamps para vasos

Gafab dilatatoren
Vascular dilators
Dilatateurs vasculaires
Dilatadores vasculares

